

MOOG

D633 and 634 Series
Servo Control Valves
with integrated 24 V Electronics
ISO 4401 Size 03 and 05



SECTION	PAGE	MOOG SERVO- AND PROPORTIONAL CONTROL VALVES
General	2	<p>For over 25 years Moog has manufactured proportional control valves with integrated electronics. During this time more than 150,000 valves have been delivered. These servo control valves have been proven to provide reliable control including injection and blow molding equipment, die casting machines, presses, heavy industry equipment, paper and lumber processing and other applications.</p> <p>D633 AND D634 SERIES SERVO CONTROL VALVES</p> <p>The D633 and D634 Series are Direct Drive Valves (DDV) with electric closed loop spool position control. These valves are throttle valves for 3-, 4-, and 2x2-way applications. They are suitable for electrohydraulic position, velocity, pressure or force control systems including those with high dynamic response requirements. The spool drive device is a permanent magnet linear force motor which can actively stroke the spool from its spring centred position in both directions. This is an advantage compared with proportional solenoids with one force direction only. The closed loop spool position electronics and pulse width modulated (PWM) drive electronics are integrated into the valve. The integrated electronics of the valves is a new development featuring SMD technology with pulse width modulated (PWM) current output stage and requires a 24 VDC power supply.</p>
Benefits and Function	3	
General technical dates, Symbols	4	
Electronics	5	
Technical Data	7	
Ordering Information	13	



The valve series described in this catalogue have successfully passed EMC tests required by EC Directive. Please refer to the respective references in the electronics section.



Valves available with explosion protection to EN 50018 and 55019, class II 2G EExde B+H₂ T4, DMT 00 ATEX E 037, CE 0470 at D633 series and II 2G EExde B+H₂ T3, DMT 00 ATEX E 037, CE 0470 at D634 series.

Note: Installation dimensions and electric connection altered. Special data sheet on request.

NOTICE

- Before installation of the valve into the system the complete hydraulic system must be flushed.
- Please read the notes in section "Electronics", page 6.

This catalogue is for users with technical knowledge. To ensure that all necessary characteristics for function and safety of the system are given, the user has to check the suitability of the products described herein. In case of doubt please contact Moog.

Our quality management system is conform to DIN EN ISO 9901.

OPERATIONAL BENEFITS OF DIRECT DRIVE SERVO VALVES (DDV)

- ❑ Directly driven by a permanent magnet linear force motor with high force level
- ❑ No pilot oil flow required
- ❑ Pressure independent dynamic performance
- ❑ Low hysteresis and low threshold
- ❑ Low current consumption at and near hydraulic null
- ❑ Standardised spool position monitoring signal with low residual ripple
- ❑ Electric null adjust
- ❑ With loss of supply voltage, or broken cable, or emergency stop the spool returns to its spring centred position without passing a load move position.

DIRECT DRIVE VALVE (DDV) OPERATION

The position control loop for the spool with position transducer and linear force motor is closed by the integrated electronics. An electric signal corresponding to the desired spool position is applied to the integrated electronics and produces a pulse width modulated (PWM) current to drive the linear force motor. An oscillator excites the spool position transducer (LVDT) producing an electric signal proportional to spool position.

The demodulated spool position signal is compared with the command signal and the resulting spool position error causes current in the force motor coil until the spool has moved to its commanded position, and the spool position error is reduced to zero. The resulting spool position is thus proportional to the command signal.

D633 Series single stage Servo Control Valve

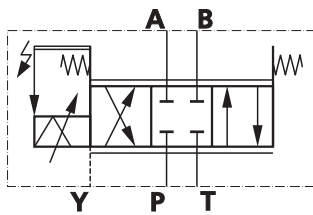

Hydraulic symbol:
Symbol shown with electric supply on and zero command signal.

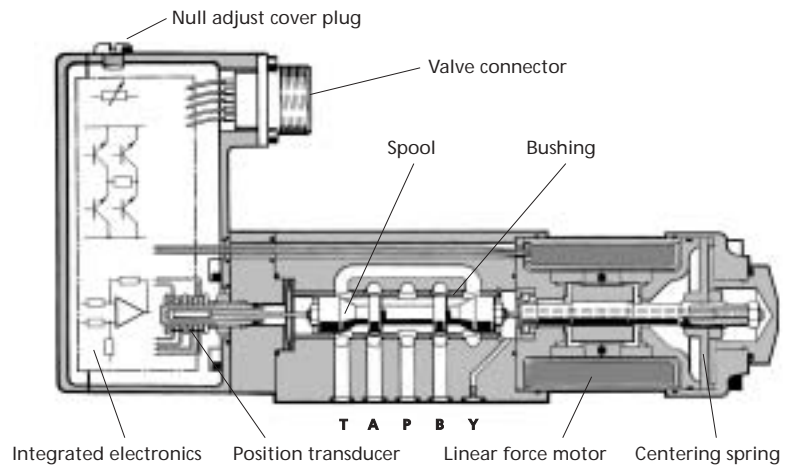

PERMANENT MAGNET LINEAR FORCE MOTOR OPERATION

The linear force motor is a permanent magnet differential motor. The permanent magnets provide part of the required magnetic force. For the linear force motor the current needed is considerably lower than would be required for a comparable proportional solenoid. The linear force motor has a neutral mid-position from which it generates force and stroke in both directions. Force and stroke are proportional to current. High spring stiffness and resulting centering force plus external forces (i.e. flow forces, friction forces due to contamination) must be overcome during out-stroking. During backstroking to centre position the spring force adds to the motor force and provides additional spool driving force which makes the valve very less contamination sensitive. The linear force motor needs very low current in the spring centred position. Proportional solenoid systems require for the same function two solenoids with more cabling. Another solution uses a single solenoid, working against a spring. In case of current loss in the solenoid, the spring drives the spool to the end position by passing through a fully open position. This can lead to uncontrolled load movements.

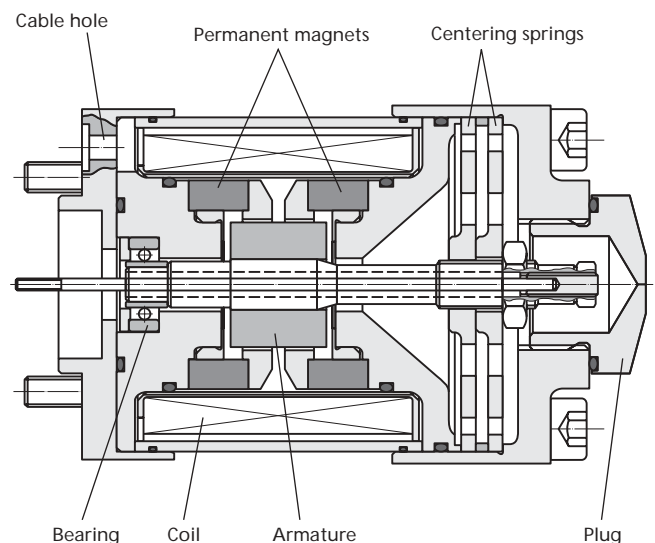

PERFORMANCE SPECIFICATIONS FOR STANDARD MODELS

Operating pressure range

Ports P, A and B up to 350 bar (5000 psi)
Port T see data for individual series

Temperature range

Ambient -20 °C to +60 °C (-4°F to +140°F)
Fluid -20 °C to +80 °C (-4°F to +170°F)

Seal material

NBR, FPM,
others on request

Operating fluid

mineral oil based hydraulic
fluid (DIN 51524, part 1 to 3),
others on request

Viscosity recommended 15 to 100 mm²/s
allowed 5 to 400 mm²/s

System filtration

High pressure filter (without bypass, but with dirt alarm) mounted in the main flow and if possible directly upstream of the valve.

Class of cleanliness

The cleanliness of the hydraulic fluid particularly effects the performance (spool positioning, high resolution) and wear (metering edges, pressure gain, leakage) of the servo valve.

Recommended cleanliness class

For normal operation ISO 4406 < 15 / 12
For longer life (wear) ISO 4406 < 14 / 11

Filter rating recommended

For normal operation $\beta_{10} \geq 75$ (10 µm absolute)
For longer life (wear) $\beta_6 \geq 75$ (6 µm absolute)

Installation options

any position,
fixed or movable

Vibration

30 g, 3 axes

Degree of protection

EN60529: class IP 65 with
mating connector mounted
Delivered with an oil sealed
shipping plate

Shipping plate

4-WAY FUNCTION

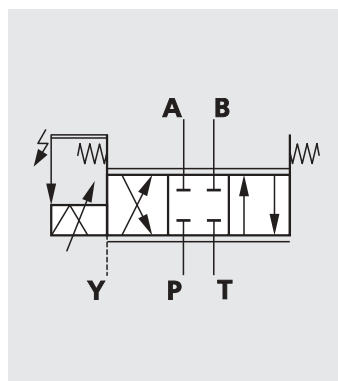

4-way version
spring centred

- Flow control (throttle valve) in port A and port B
- Port Y required if pressure $p_T > 50$ bar (715 psi) in port T
- for 3-way function close port A or port B of the manifold
- Spools with exact axis cut, 1,5 to 3 % or 10 % overlap available

2X2-WAY FUNCTION

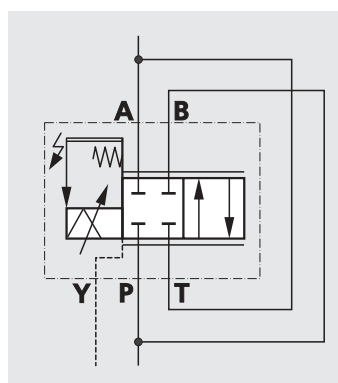

2x2-way version
(Y-Port required)

- Flow control (throttle valve) in port A
- Port Y required
- Connect externally port P with port B, and port A with port T

VALVE FLOW CALCULATIONS

The actual valve flow is dependent on the spool position and the pressure drop across the spool lands.

At 100% command signal (i.e. +10 VDC = 100% valve opening) the valve flow at rated pressure drop $\Delta p_N = 35$ bar per metering land is the rated flow Q_N . For other than rated pressure drop the valve flow changes at constant command signal according to the square root function for sharp edged orifices.

$$Q = Q_N \cdot \sqrt{\frac{\Delta p}{\Delta p_N}}$$

Q [l/min] = calculated flow

Q_N [l/min] = rated flow

Δp [bar] = actual valve pressure drop

Δp_N [bar] = rated valve pressure drop

The real valve flow Q calculated in this way should result in an average flow velocity in ports P, A, B or T of less than 30 m/s.

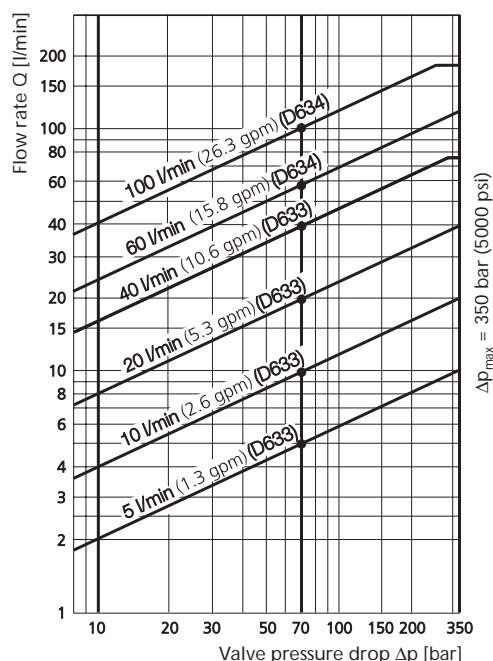

VALVE ELECTRONICS WITH SUPPLY VOLTAGE 24 VOLT AND 6+PE POLE CONNECTOR

Command signal 0 to ±10 mA

floating, Valves with current command input

The spool stroke of the valve is proportional to $I_D = -I_E$.
 100 % valve opening $P \rightarrow A$ and $B \rightarrow T$ is achieved at $I_D = +10$ mA. At 0 mA command the spool is in centred position. The input pins D and E are inverting. Either pin D or E is used according to the required operating direction. The other pin is connected to signal ground at cabinet side.

Command signal 0 to ±10 V,

Valves with voltage command input

The spool stroke of the valve is proportional to $(U_D - U_E)$.
 100 % valve opening $P \rightarrow A$ and $B \rightarrow T$ is achieved at $(U_D - U_E) = +10$ V.
 At 0 V command the spool is in centred position. The input stage is a differential amplifier. If only one command signal is available, pin D or E is connected to signal ground at cabinet side, according to the required operating direction.

Actual value 4 to 20 mA

The actual spool position value can be measured at pin F (see diagram below). This signal can be used for monitoring and fault detection purposes.

The spool stroke range corresponds to 4 to 20 mA.

The centred position is at 12 mA. 20 mA corresponds to 100 % valve opening $P \rightarrow A$ and $B \rightarrow T$. The position signal output 4 to 20 mA allows to detect a cable break when $I_F = 0$ mA.

Circuit diagram for measurement of actual value I_F (position of spool) for valves with 6+PE pole connector

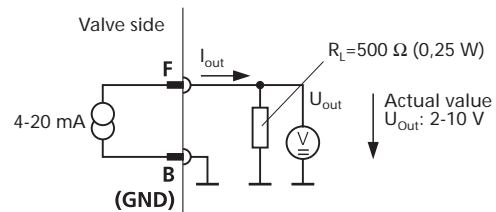

The position signal output 4 to 20 mA allows to detect a cable break when $I_F = 0$ mA.

For failure detection purposes it is advised to connect pin F of the mating connector and route this signal to the control cabinet.

WIRING FOR VALVES WITH 6+PE POLE CONNECTOR

to EN 175201 Part 804¹⁾, and mating connector (type R and S, metal shell) with leading protective earth connection (\perp). See also Application Note AM 426 E.

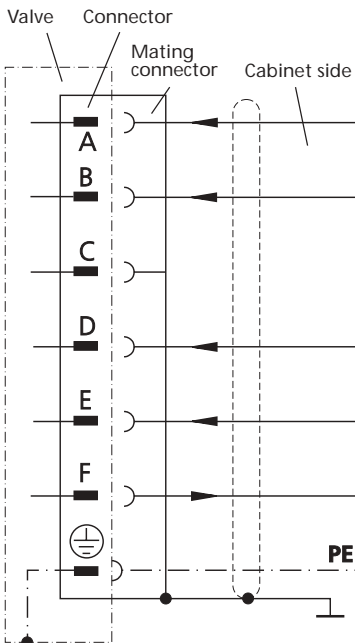

Function	Current command 0 to ± 10 mA floating	Voltage command 0 to ± 10 VDC
Supply	24 VDC (19 to 32 VDC)	
Supply / Signal ground	\perp (0 V)	
not used		
Input rated command (differential)	Input command $I_D = -I_E$: 0 to ± 10 mA Input command (inv.) $I_E = -I_D$: 0 bis ± 10 mA ($R_e = 200 \Omega$)	$U_{D-E} = 0$ bis ± 10 V $R_e = 10 \text{ K}\Omega$
Output actual valve spool position	$I_{F-B} = 4$ to 20 mA. At 12 mA spool is in centred position. $R_L = 300$ to 500 Ω	
Protective earth		

¹⁾ formerly DIN 43563

PERFORMANCE SPECIFICATIONS FOR STANDARD MODELS

Model . . . Type		D633
Mounting pattern with or without leakage port Y ³⁾		ISO 4401-03-03-0-94
Port diameter	mm (in)	7.9 (0.31)
Valve version ³⁾		Single stage, spool in bushing 3-way, 4-way, 2x2-way
Spool actuation		directly, with permanent magnet linear force motor
Pilot supply		none
Mass	kg (lb)	2.5 (5.5)
Rated flow ($\pm 10\%$) at $\Delta p_N = 35$ bar per land	l/min (gpm)	5 / 10 / 20 / 40 (1.3 / 2.6 / 5.3 / 10.6)
Max. valve flow	l/min (gpm)	75 (19.8)
Operating pressure max.		
Ports P,A,B	bar (psi)	350 (5000)
Port T ohne Y	bar (psi)	50 (715)
Port T mit Y	bar (psi)	350 (5000)
Port Y	bar (psi)	directly to tank
Response time for 0 to 100% stroke, typical	ms	≤ 12
Threshold ¹⁾	%	< 0.1
Hysteresis ¹⁾	%	< 0.2
Null shift ¹⁾ with $\Delta T = 55$ K	%	< 1.5
Null leakage flow ¹⁾ max. (axis cut)	l/min (gpm)	0.15 / 0.3 / 0.6 / 1.2 (0.04 / 0.08 / 0.16 / 0.32)

- 1) At operating pressure $p_p = 140$ bar (2000psi), fluid viscosity of $32 \text{ mm}^2/\text{s}$ ($0.05 \text{ in}^2/\text{s}$) and fluid temperature of $40 \text{ }^\circ\text{C}$ ($104 \text{ }^\circ\text{F}$)
- 2) See symbols page 4
- 3) Leakage port Y must be used
 - with 3- and 4-way function and $p_T > 50$ bar (715psi)
 - with 2x2-way function

CHARACTERISTIC CURVES (TYPICAL)

Step response

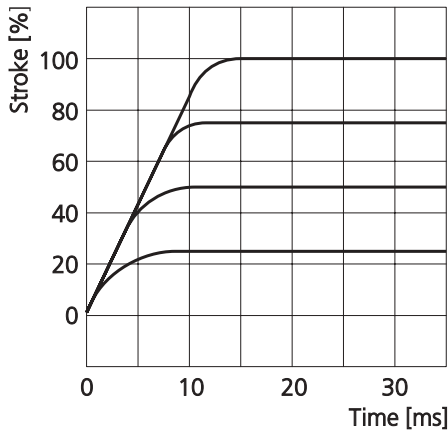

Flow signal characteristic curve

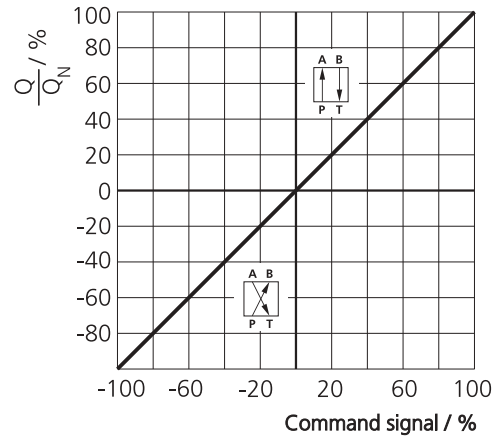

Frequency response

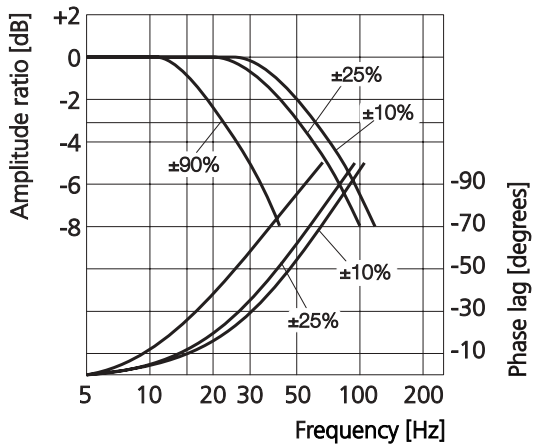

Valve flow diagram

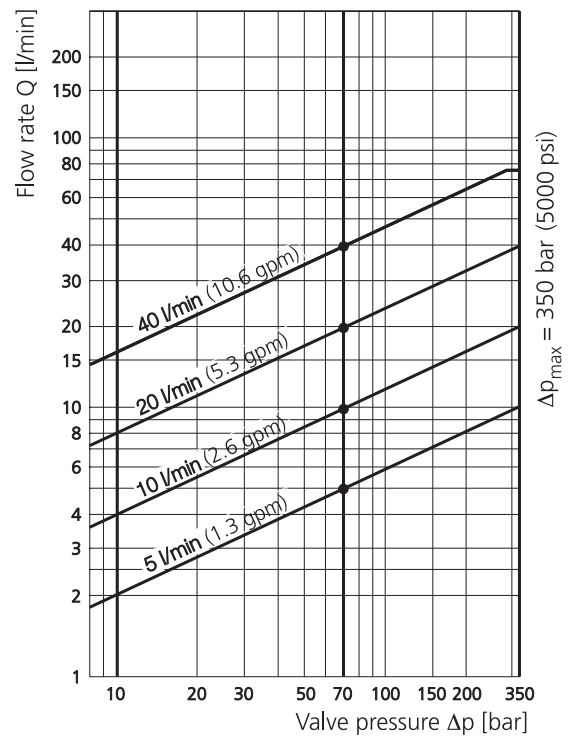

Pressure signal characteristic curve

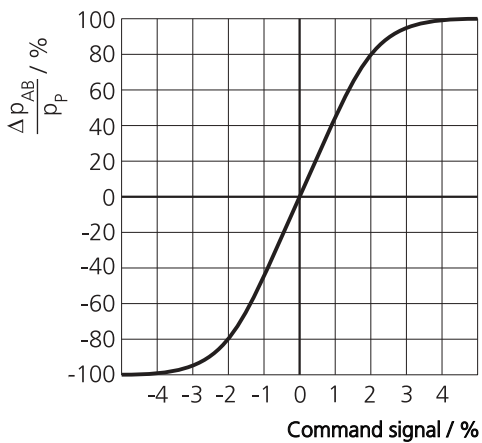

INSTALLATION DRAWING

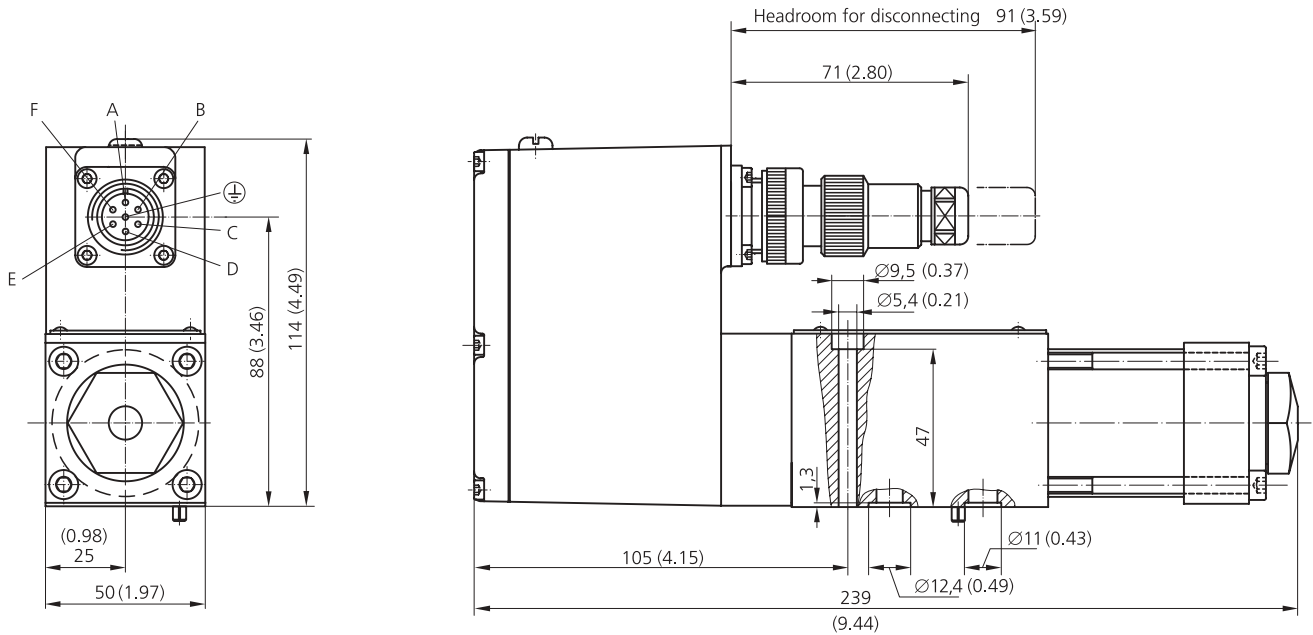

Mounting pattern

ISO 4401-03-03-0-94, without X port

mm

	P	A	B	T	X ¹⁾	Y	F ₁	F ₂	F ₃	F ₄	G
	Ø7,5	Ø7,5	Ø7,5	Ø7,5		Ø3,3	M5	M5	M5	M5	4
x	21,5	12,7	30,2	21,5		40,5	0	40,5	40,5	0	33
y	25,9	15,5	15,5	5,1		9	0	-0,75	31,75	31	31,75

inch

	P	A	B	T	X ¹⁾	Y	F ₁	F ₂	F ₃	F ₄	G
	Ø0.30	Ø0.30	Ø0.30	Ø0.30		Ø0.13	M5	M5	M5	M5	0.16
x	0.85	0.50	1.19	0.85		1.60	0	1.60	1.60	0	1.30
y	1.02	0.61	0.61	0.20		0.35	0	-0.03	1.25	1.22	1.25

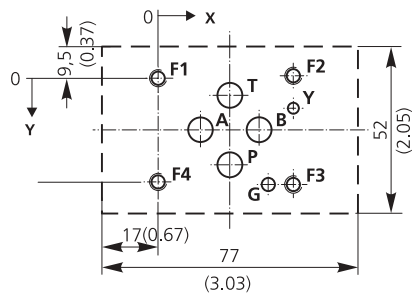

1) Port X must not be drilled, not sealed at valve base.

Mounting surface needs flat within 0,01 mm (0.0004 in) over a distance of 100 mm (3.94 in). Average surface finish value, Ra = 0.8 µm.

Spare parts and Accessories

O-Rings (included in delivery)		NBR 90 Shore	FPM 90 Shore
for ports P,T,A,B	4 pieces ID 9,25 x Ø 1,8 (ID 0.36 x Ø 0.07)	45122 013	42082 013
for port Y	1 piece ID 7,65 x Ø 1,8 (ID 0.30 x Ø 0.07)	45122 012	42082 012
Mating connector, waterproof IP65 (not included in delivery)		for cable dia	min. Ø 10 mm (0.394 in), max. Ø 12 mm (0.472 in)
6+PE-pole	B97007 061	EN 175201 Part 804	
Flushing plates	for P,A,B,T,X,Y B46634 002		
Mounting manifolds	on request		
Mounting bolts (not included in delivery)		required torque	required
M 5 x 55 DIN EN ISO 4762-10.9	A03665 050 055	8.5 Nm (75 inch pounds)	4 pieces

PERFORMANCE SPECIFICATIONS FOR STANDARD MODELS

Model . . . Type		D634
Mounting pattern with or without leakage port Y ³⁾		ISO 4401-05-05-0-94
Port diameter	mm (in)	11.5 (0.45)
Valve version ²⁾		Single stage, spool in bushing 3-way, 4-way, 2x2-way
Spool actuation		directly, with permanent magnet linear force motor
Pilot supply		none
Mass	kg (lb)	6.3 (13.9)
Rated flow ($\pm 10\%$) at $\Delta p_N = 35$ bar per land	l/min (gpm)	60 / 100 (15.8 / 26.3)
Max. valve flow	l/min (gpm)	185 (48.8)
Operating pressure max.		
Ports P,A,B	bar (psi)	350 (5000)
Port T ohne Y	bar (psi)	50 (715)
Port T mit Y	bar (psi)	350 (5000)
Port Y	bar (psi)	directly to tank
Response time for 0 to 100% stroke, typical	ms	≤ 20
Threshold ¹⁾	%	< 0.1
Hysteresis ¹⁾	%	< 0.2
Null shift ¹⁾ with $\Delta T = 55$ K	%	< 1.5
Null leakage flow ¹⁾ max. (axis cut)	l/min (gpm)	1.2 / 2.0 (0.26 / 0.43)

1) At operating pressure $p_p = 140$ bar (2000 psi), fluid viscosity of $32 \text{ mm}^2/\text{s}$ ($0.05 \text{ in}^2/\text{s}$) and fluid temperature of $40 \text{ }^\circ\text{C}$ ($104 \text{ }^\circ\text{F}$)

2) See symbols page 4

3) Leakage port Y must be used
 with 3- and 4-way function and $p_T > 50$ bar (715 psi)
 with 2x2-way function

CHARACTERISTIC CURVES (TYPICAL)

Step response

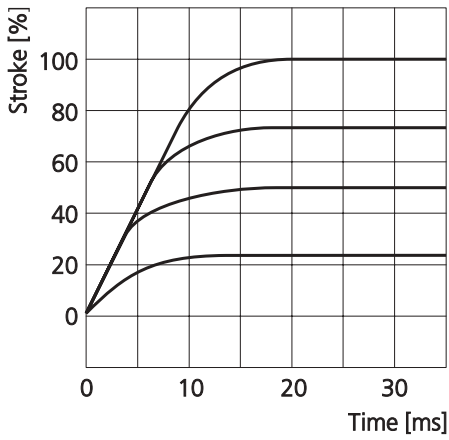

Flow signal characteristic curve

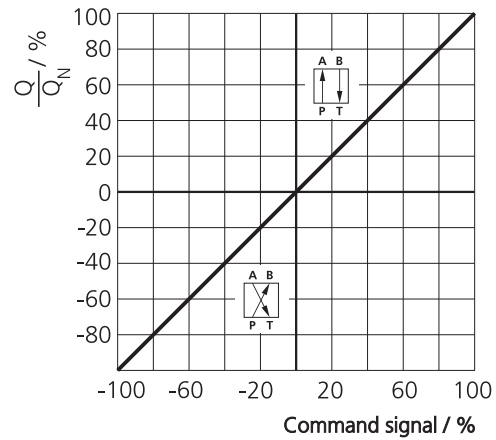

Frequency response

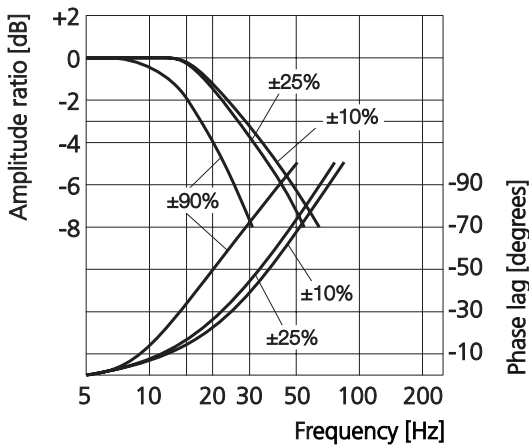

Valve flow diagram

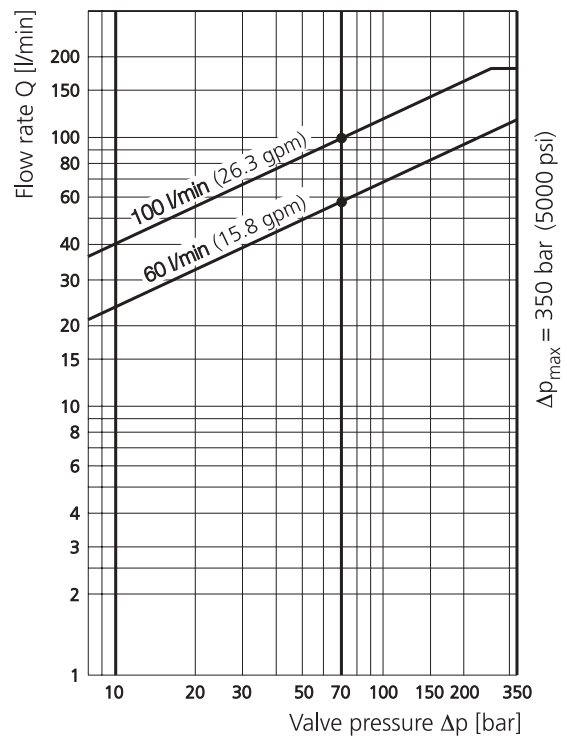

Pressure signal characteristic curve

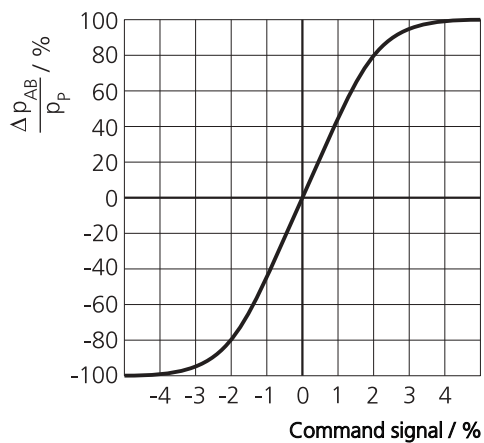

INSTALLATION DRAWING

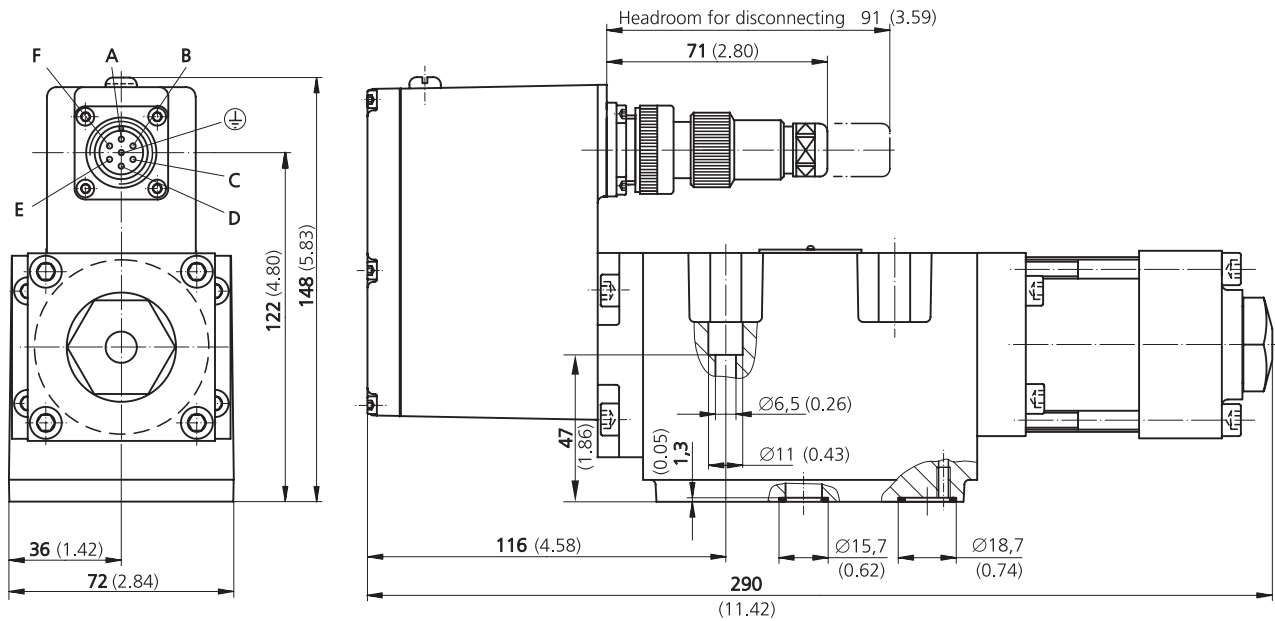

Mounting pattern

ISO 4401-05-05-0-94, without X port

mm

	P	A	B	T	T ₂	X ¹⁾	Y	F ₁	F ₂	F ₃	F ₄
	Ø11,2	Ø11,2	Ø11,2	Ø11,2	Ø11,2		Ø 6,3	M6	M6	M6	M6
x	27	16,7	37,3	3,2	50,8		62	0	54	54	0
y	6,3	21,4	21,4	32,5	32,5		11	0	0	46	46

inch

	P	A	B	T	T ₂	X ¹⁾	Y	F ₁	F ₂	F ₃	F ₄
	Ø0.44	Ø0.44	Ø0.44	Ø0.44	Ø0.44		Ø 0.25	M6	M6	M6	M6
x	1.06	0.66	1.47	0.13	2.00		2.44	0	2.13	2.13	0
y	0.25	0.84	0.84	1.28	1.28		0.43	0	0	1.81	1.81

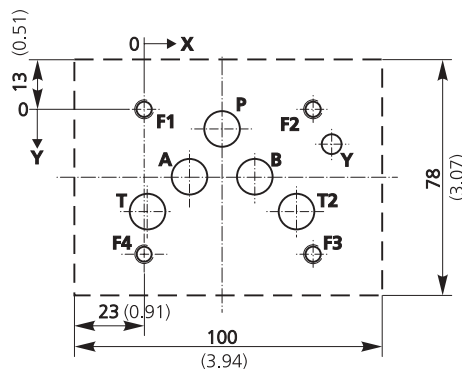

¹⁾ Port X must not be drilled, not sealed at valve base.

Mounting surface needs flat within 0,01 mm (0.0004 in) over a distance of 100 mm (3.94 in). Average surface finish value, Ra = 0.8 µm.

Spare parts and Accessories

O-Rings (included in delivery) for ports P,T,T ₂ ,A,B for port Y	5 pieces ID 12.4 x Ø 1.8 (ID 0.49 x Ø 0.07) 1 piece ID 15.6 x Ø 1.8 (ID 0.61 x Ø 0.07)	NBR 90 Shore 45122 004 45122 011	FPM 90 Shore 42082 004 42082 011
Mating connector, waterproof IP65 (not included in delivery) 6+PE-pole	B97007 061	EN 175201 Part 804	for cable dia min. Ø 10 mm (0.394 in), max. Ø 12 mm (0.472 in)
Flushing plates	for P,A,B,T,T ₂ ,X,Y B67728 001		
Flushing plates	for P,A,B,T,T ₂ ,X,Y B67728 002		
Flushing plates	for P,A,B,T,T ₂ ,X,Y B67728 003		
Mounting manifolds	on request		
Mounting bolts (not included in delivery) M 6 x 60 DIN EN ISO 4762-10.9 A03665 060 060	required torque 13 Nm (115 inch pounds)	required 4 pieces	

ORDERING INFORMATION

Model-Number

D 63

Type designation

.

Series	
3	Size 03
4	Size 05

Specification-Status	
-	Series specification
E	Preseries specification
K	explosion proof version upon request
Z	Special specification

Model designation	
	assigned at the factory

Factory identification

Valve version	
R	with integrated electronics

Rated flow			
	Q_N [l/min] at $\Delta p_N = 35$ bar (Q_N [gpm] at $\Delta p_N = 500$ psi)	$\Delta p_N = 5$ bar per land	Series
02	5 (1.3)	2	D633
04	10 (2.6)	4	D633
08	20 (5.3)	8	D633
16	40 (10.6)	16	D633
24	60 (15.8)	24	D634
40	100 (26.3)	40	D634

Maximum operating pressure	
K	350 bar (5000 psi)

Options may increase price and delivery.
All combinations may not be available.
Preferred configurations are highlighted.
Technical changes are reserved.

Supply voltage	
2	24 VDC (19 to 32 VDC)

Signals for 100% spool stroke*		
	Command	Output
M	± 10 VDC	+4 to +20 mA
X	± 10 mA, floating	+4 to +20 mA deadband compensation on request

Valve connector	
S	6+PE pole EN 175201 Part 804

Seal material	
N	NBR (Buna)
V	FPM (Viton) others on request

Y- port		
0	closed with plug	$p_{Tmax} = 50$ bar (715 psi)
3	open, with filter insert	$p > 50$ bar (715 psi)

Spool position without electric supply	
M	mid position
F	P \blacktriangleright B, A \blacktriangleright T connected (10% open)
D	P \blacktriangleright A, B \blacktriangleright T connected (10% open) other openings on request

Linear motor		
	Standard	Series
1		D633
2		D634

Bushing / Spool type		
0	4-way:	axis cut, linear characteristic
A	4-way:	1,5 to 3% overlap, linear characteristic
D	4-way:	10% overlap, linear characteristic
Z	2x2-way:	P \blacktriangleright A, B \blacktriangleright T, with Y-port only
X		Special spool on request

*(input voltage limited, see page 6)



Argentina
Australia
Austria
Brazil
China
Finland
France
Germany
India



Ireland
Italy
Japan
Korea
Luxembourg
Norway
Russia
Singapore
Spain
Sweden
United Kingdom
USA

MOOG

Moog GmbH
Hanns-Klemm-Straße 28
71034 Böblingen
email: sales@moog.de
www.moog.de
Telefon (0 70 31) 622-0
Telefax (0 70 31) 622-191

D633/634.de.05.02